

SPECIALTY ELECTRIC KITS

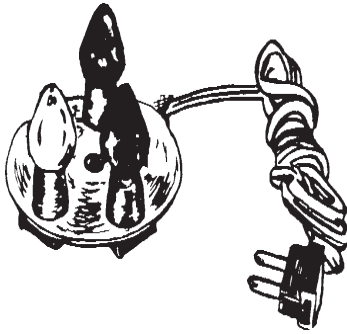

3 STROBE LIGHT KIT

- 1 - \$5.25ea
- 6 - \$5.00ea
- 12 - \$4.90ea

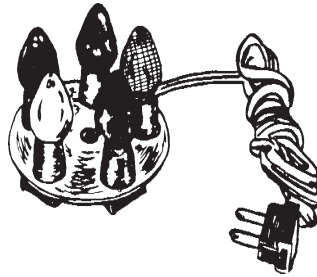

5 STROBE LIGHT KIT

- 1 - \$5.50ea
- 6 - \$5.25ea
- 12 - \$5.10ea

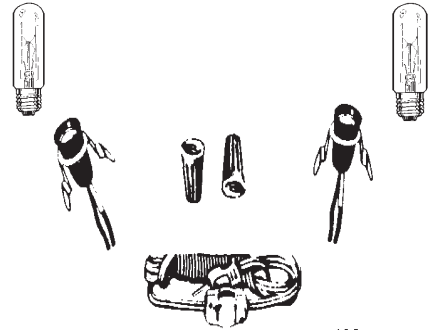

SMALL WREATH LARGE WREATH KIT (7 1/2 WATT) KIT (25 WATT)

- | | |
|---------------|---------------|
| 1 - \$4.25ea | 1 - \$4.75ea |
| 6 - \$3.75ea | 6 - \$3.95ea |
| 12 - \$3.60ea | 12 - \$3.90ea |

STREET LAMP KIT (UNASSEMBLED LITE KIT)

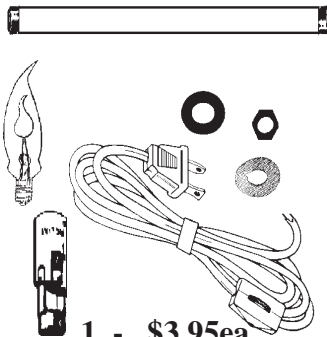

- 1 - \$3.95ea
- 6 - \$3.50ea
- 12 - \$3.00ea

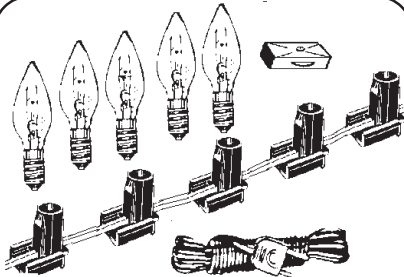

5 LIGHT VILLAGE KIT (7 1/2 WATT)

- 1 - \$5.50ea
- 6 - \$5.25ea
- 12 - \$4.90ea

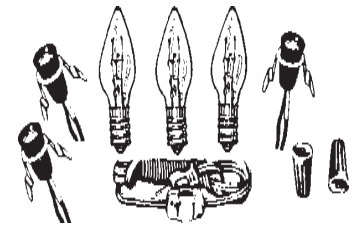

ANGEL KIT

- 1 - \$4.50ea
- 6 - \$4.00ea
- 12 - \$3.80ea

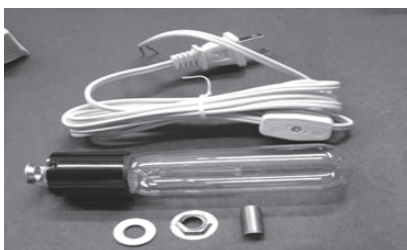

LARGE TREE KIT

- 1 - \$3.50ea
- 6 - \$3.25ea
- 24 - \$3.00ea
- 50 - \$2.85ea
- 100 - \$2.75ea

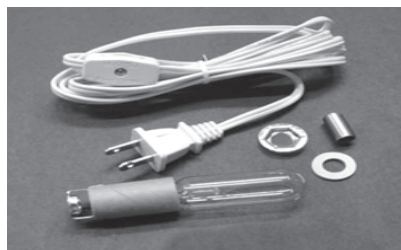

SMALL TREE KIT

- 1 - \$3.00ea
- 6 - \$2.85ea
- 24 - \$2.75ea
- 50 - \$2.65ea
- 100 - \$2.50ea

LAMP POST KIT 6FT. - WHITE ONLY Plug Not Attached



- 1 - 2.50ea
- 3 - 2.00ea
- 6 - 1.90ea
- 12 - 1.75ea

PRICES SUBJECT TO CHANGE WITHOUT NOTICE